

Blocco: MAIN
 Autore:
 Data di creazione: 22.10.2009 1:21:47
 Ultima modifica: 23.10.2009 1:12:04

Simbolo	Tipo variabile	Tipo di dati	Commento
	TEMP		
	TEMP		
	TEMP		
	TEMP		

DISTRIBUTORE AUTOMATICO

Segmento 1

Letture monete da 10 cent.

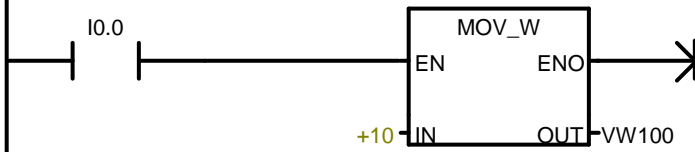

Segmento 2

Letture monete da 20 cent.

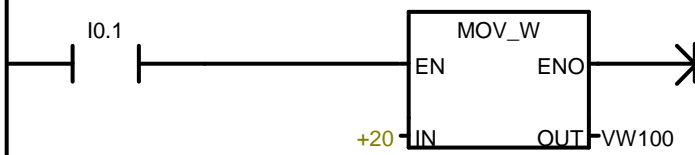

Segmento 3

Letture monete da 50 cent.

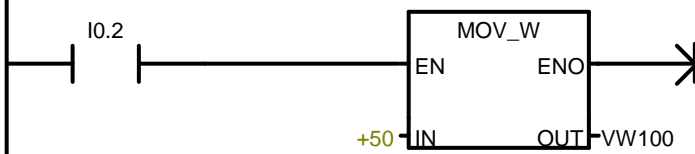

Segmento 4

Reset lettura (avviene non appena il sensore torna a riposo)

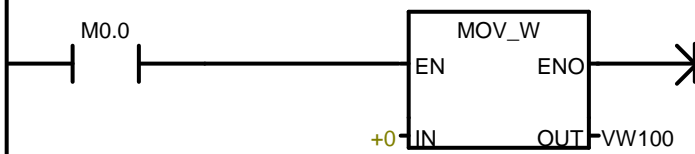

Segmento 5

Conteggio credito inserito

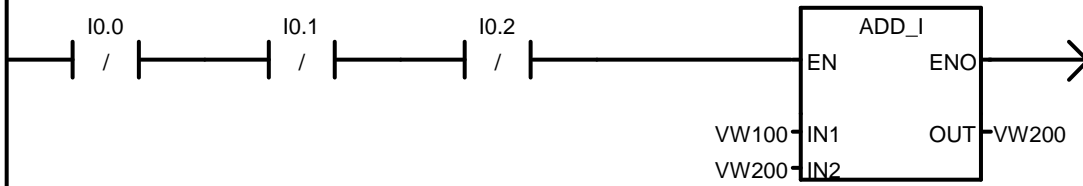

Segmento 6

Reset lettura

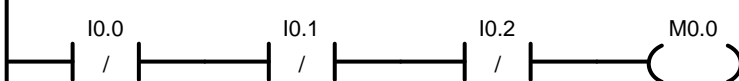

Segmento 7

Reset credito inserito

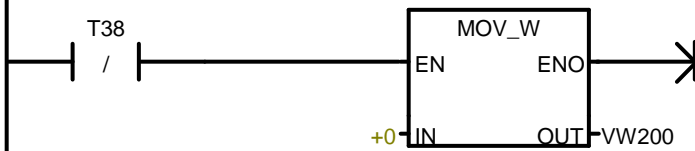

Segmento 8

Quando viene selezionato un prodotto l' importo corrispondente (in questo caso 30 cent.) viene caricato in VW400 e successivamente (al rilascio del pulsante) in VW500.
Il "contatto" di confronto consente l' operazione solo se il credito residuo (VW700) è maggiore o uguale all' importo del prodotto.

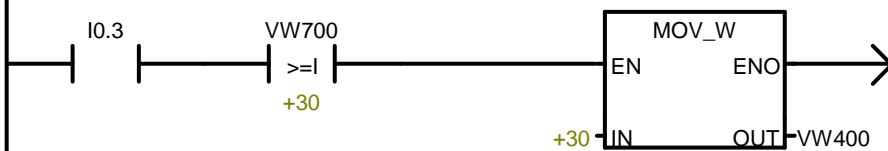

Segmento 9

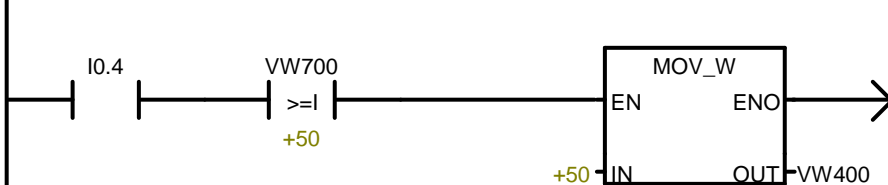

Segmento 10

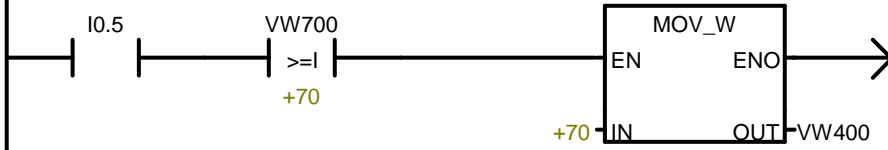

Segmento 11

Non appena viene rilasciato il pulsante il valore di VW400 si azzerava.

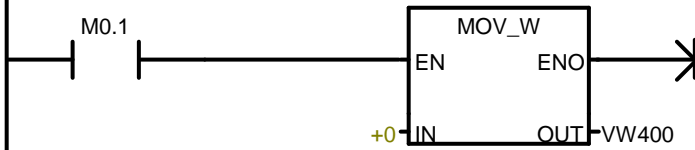

Segmento 12

Conteggio credito utilizzato

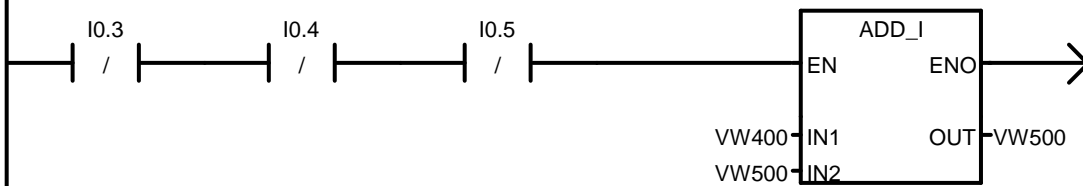

Segmento 13

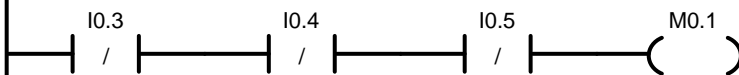

Segmento 14

Credito residuo (differenza tra credito inserito e credito utilizzato)

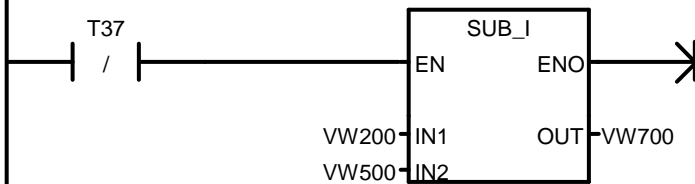

Segmento 15

Reset credito utilizzato

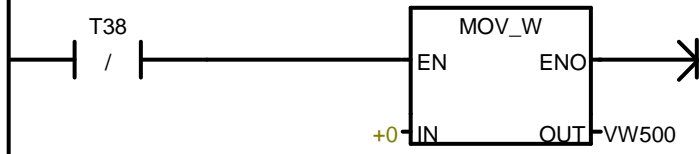

Segmento 16

Erogazione prodotto 1 (importo 30 cent.)

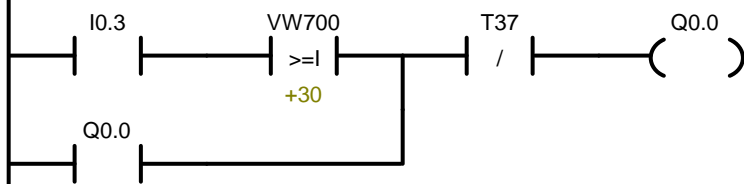

Segmento 17

Erogazione prodotto 2

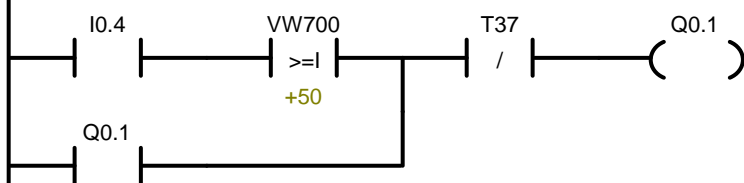

Segmento 18

Erogazione prodotto 3

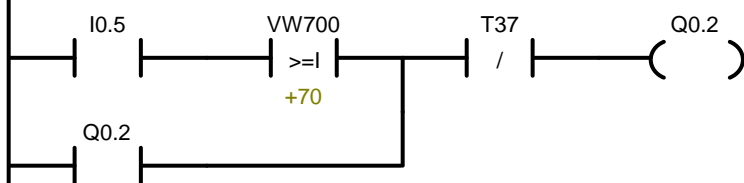

Segmento 19

La fase di erogazione dura 3 secondi

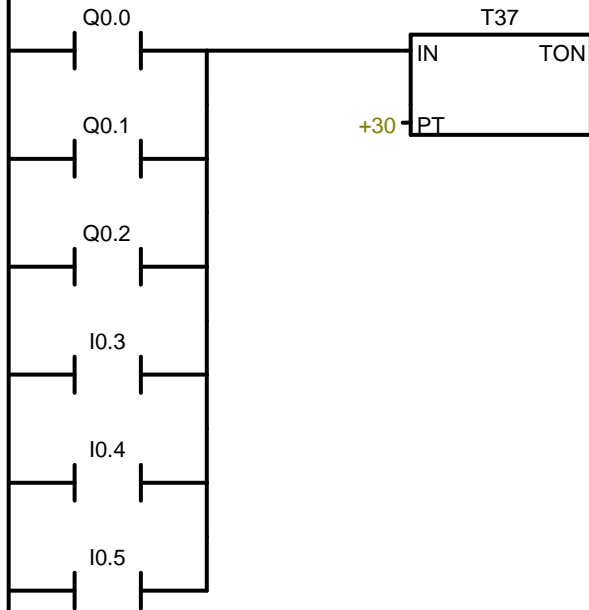

Segmento 20

Dopo 1 minuto di inattività vengono azzerati i conteggi

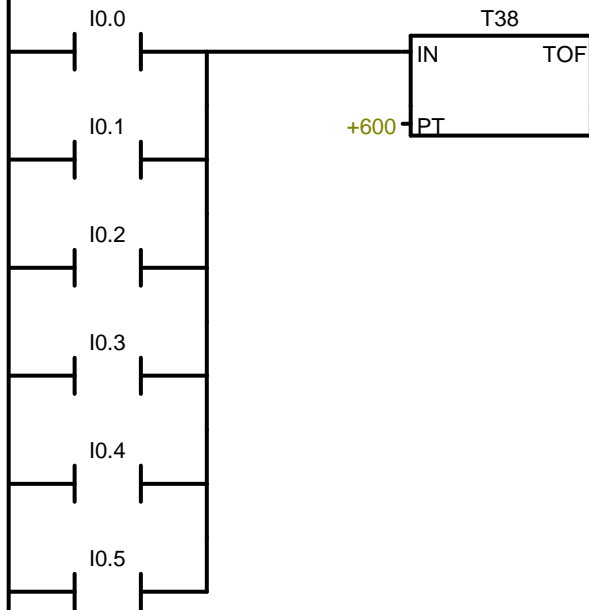

Blocco: SBR_0
Autore:
Data di creazione: 22.10.2009 1:21:47
Ultima modifica: 22.10.2009 1:21:47

Simbolo	Tipo variabile	Tipo di dati	Commento
EN	IN	BOOL	
	IN		
	IN_OUT		
	OUT		
	TEMP		

COMMENTI DEL SOTTOPROGRAMMA

Segmento 1 Titolo del segmento

Commento del segmento

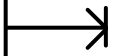

Blocco: INT_0
Autore:
Data di creazione: 22.10.2009 1:21:47
Ultima modifica: 22.10.2009 1:21:47

Simbolo	Tipo variabile	Tipo di dati	Commento
	TEMP		
	TEMP		
	TEMP		
	TEMP		

COMMENTI DELLA ROUTINE DI INTERRUPT

Segmento 1 Titolo del segmento

Commento del segmento

